



SMART SOCA

Self-Optimizing
Smart Cellular
Antenna Solutions



HARDWARE: SOCA ROTATOR

SIDE VIEW

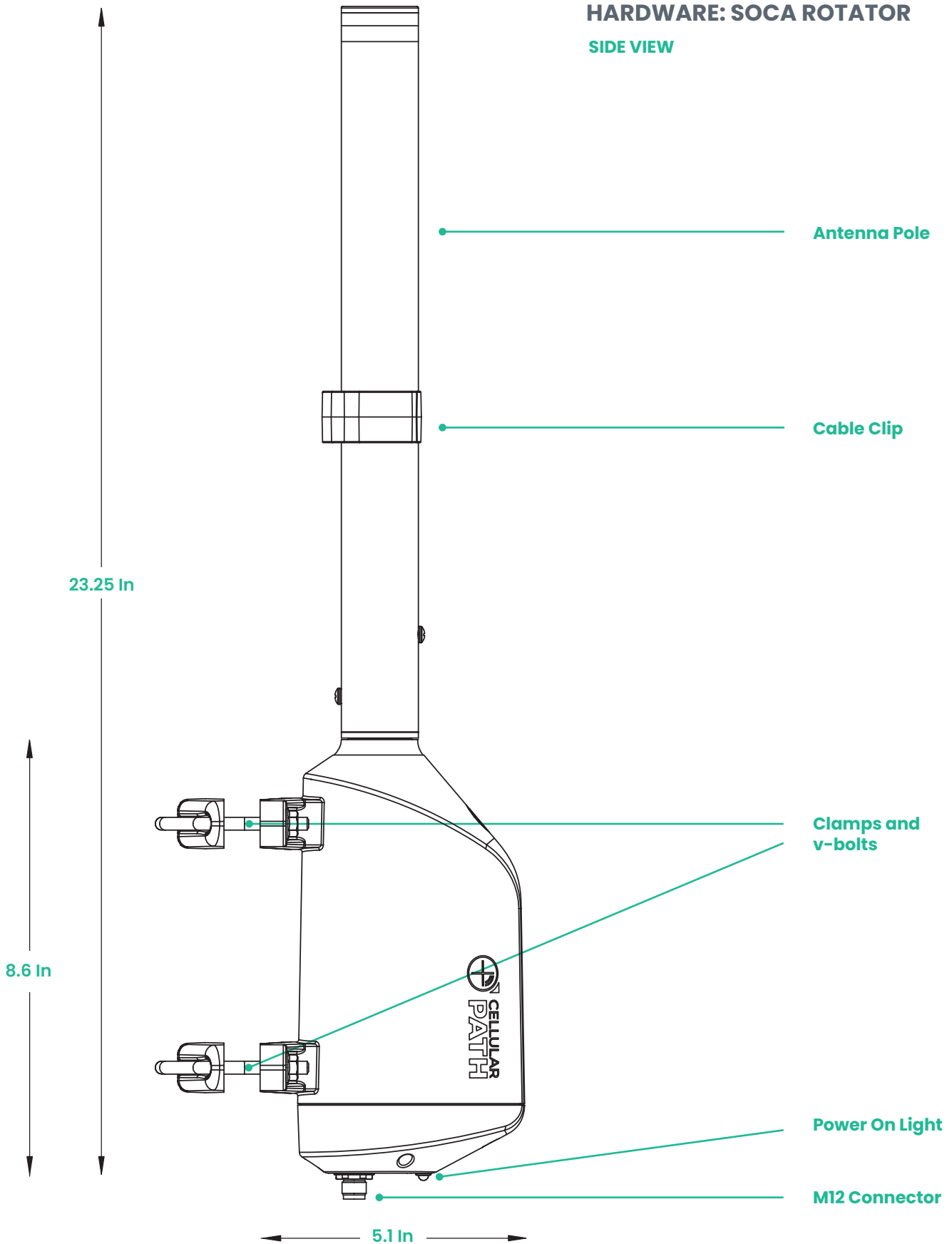



FEATURES: SOCA ROTATOR

PHYSICAL SPECIFICATIONS

Casing material	Die cast aluminum and glass filled polycarbonate
Device (W x H x D)	5.15 x 11.5 x 3.9 inches
Box (W x H x D):	15.6 x 7.7 x 7 inches
Weight (product)	5 lbs
Weight (complete box)	8 lbs
Mounting options	2 x V-Bolts with Flanged Nuts
Pole Length	14 Inches
Wind Rating	60 mph Sustained winds. Up to 90 mph Wind Gusts
Max. Antenna weight	80lbs

POWER

Connector	4 PIN M12
Input voltage range:	12V
Power consumption	1A

OPERATING ENVIRONMENT

Operating temperature	-20° F to 140° F
Operating humidity	Up to 100%
Ingress Protection Rating	IPX2
UV Resistance	UL 746C (F1 long-term UV exposure)
Salt Spray	ASTM 8117

HARDWARE: SMART SOCA CONTROLLER (With CMB 100 Telit Modem)

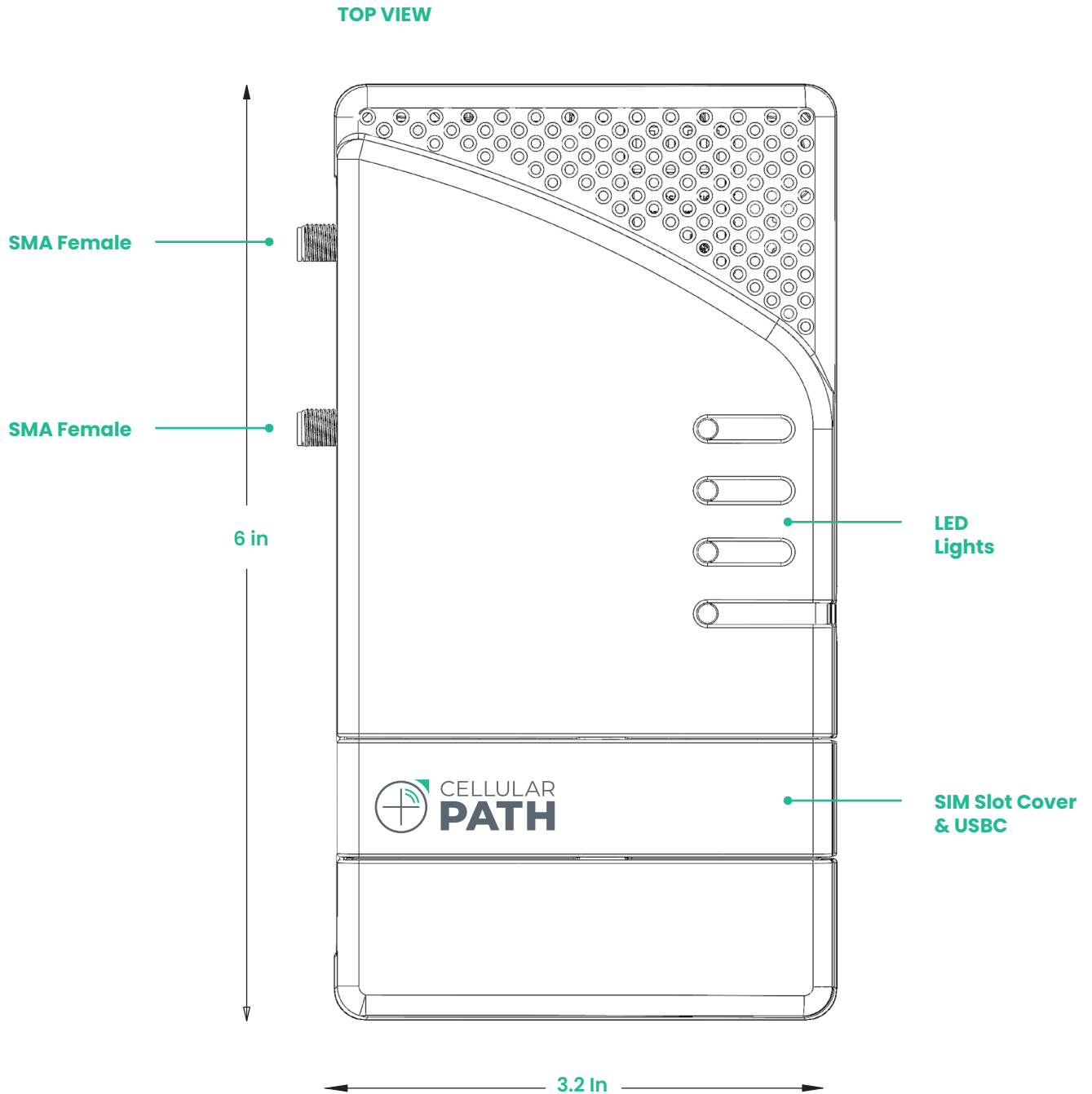



HARDWARE: SMART SOCA CONTROLLER (With CMB 100 Telit Modem)

BACK VIEW

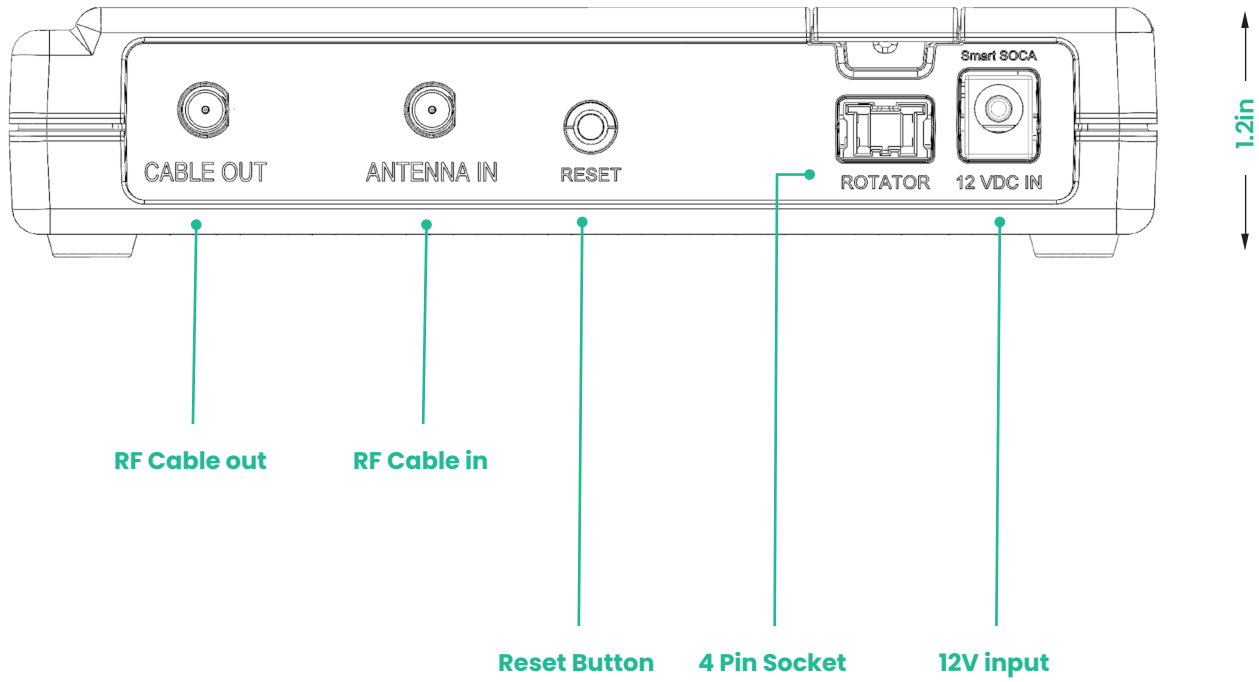

FRONT VIEW

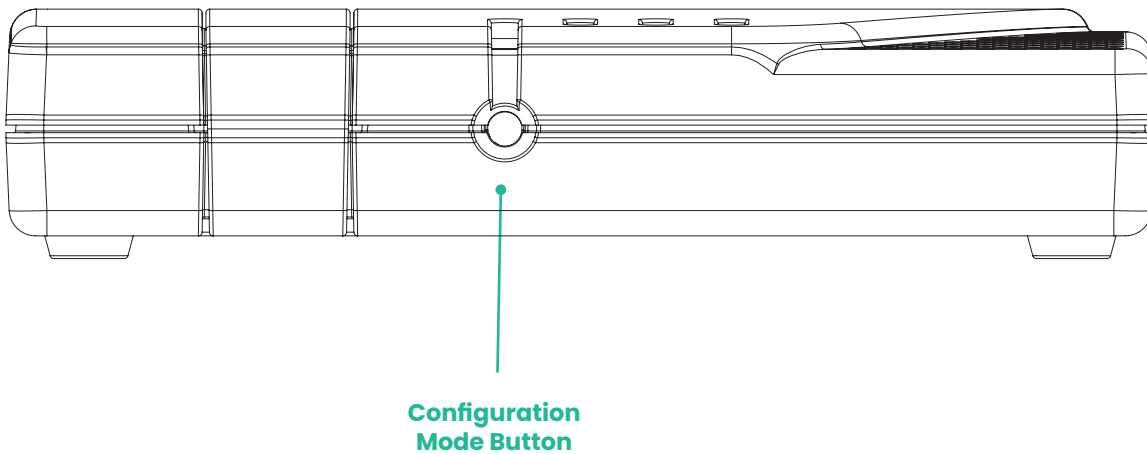



FEATURES: SMART SOCA CONTROLLER (With CMB 100 Telit Modem)

PHYSICAL SPECIFICATIONS

Casing material	PC/ABS Blend
Device (W x H x D)	6 x 3.2 x 1.3 inches
Weight (product)	0.5 lbs

RF Data

Impedance	50 Ohm
Telit Module	CMB100A0-WW
Bands Supported	B1, B2, B3, B4, B5, B7, B8, B9, B12, B13, B14, B18, B19, B20, B25, B26, B28

WIRELESS

Wireless mode	ESP32-S3 supports a 2.4 GHz Wi-Fi (802.11 b/g/n) with 40 MHz of bandwidth
Wi-Fi security	WPA2-Enterprise: PEAP, WPA2-PSK
SIM	1 x SIM slots (Mini SIM – 2FF), 1.8 V/3 V
RF Connectors	2 x SMA Jack, Female Socket

POWER

Power Adapter	12V, 2A power adapter (2.1mm x 5.5mm center positive)
SIM	1 x Nano SIM (4FF)
Input voltage range:	12V
Power consumption	2A
Connector from Rotator	1 x 4-pin power connector

OPERATING ENVIRONMENT

Operating temperature	-20° F to 140° F
Operating humidity	Up to 100%

PACKING LIST INFORMATION

STANDARD PACKAGE*

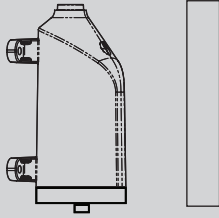

SOCA ROTATOR + POLE



SOCA CONTROLLER (Telit Modem)



INSTALLATION MANUAL

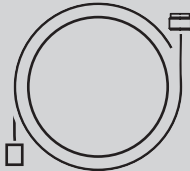

50FT CABLE

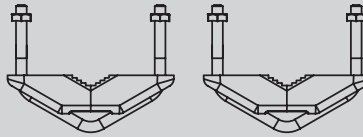

2 X BRACKETS WITH V-BOLTS

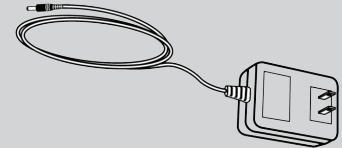

POWER ADAPTER

* Standard package contents are different for provided standard order codes.

For more information on all available packaging options – please [contact us](#) or email us at support@cellularpath.com

AVAILABLE VERSIONS

North America

SMART SOCA: SOCA-01-T-4G50

International

SMART SOCA: SOCA-01-T-IN-4G50

REGULATORY AND TYPE APPROVALS

Type Approval

FCC Part 15(b) (North America)